

Smart Spa



TuSPA
#incasa

APP Ewelink
EWelink APP



Panel digital
Digital panel



Válvula de llenado
Filling valve



Caja Smart Spa
Smart Spa box



Sensor de llenado
Fill Sensor



Válvula de vaciado
Drain valve



Un día cualquiera en el trabajo...

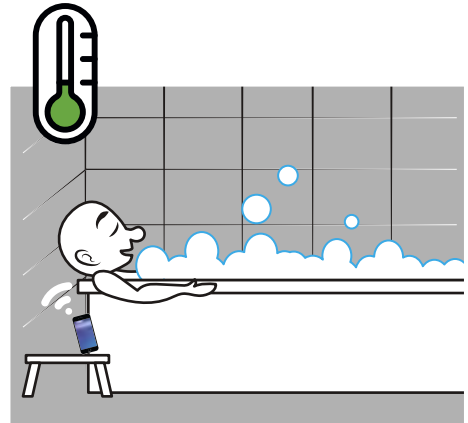
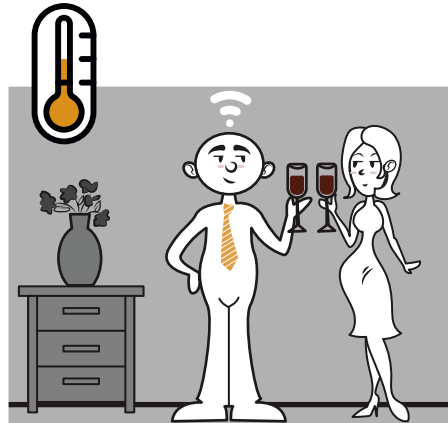
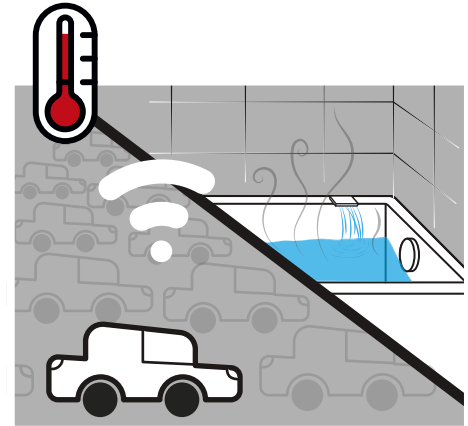
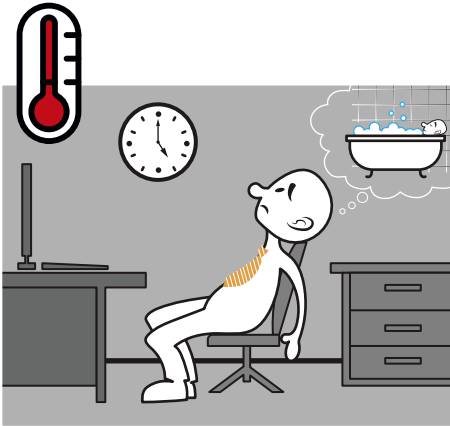

Funcionamiento general / General operation

- 1 Conectar hidromasaje y verificar funcionamiento.
Connect hydromassage and check functionality.

Funcionamiento básico para hidromasajes panel 3 botones *Basic operation for whirlpool bath panel 3 buttons:*



Cromoterapia
Chromotherapy



Aeroterapia
Airtherapy



Hidroterapia
Hydrotherapy



Encendido, selección de color y apagado
de cromoterapia
On, color selection and chromotherapy off



Encendido y apagado de los jets de aire
On and off the air jets

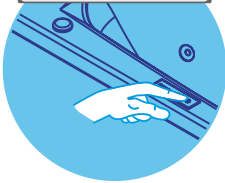

Encendido y apagado de los jets de agua
On and Off the hydro jets



IMPORTANTE: Cualquier botón inicia el llenado y las terapias del hidromasaje. Al apagar la última terapia, ésta iniciará el vaciado para luego apagar todo el sistema de terapias.

IMPORTANT: Any button starts filling and therapy of the Whirlpool bath. Turning off the last therapy will start the emptying and then turn off the entire therapeutic system.

- 2 Verificar la red Wifi, asegúrate de estar conectado a la wifi con el celular.

¿Qué hacer si no hay señal?

1. Si intentas conectarte a una nueva red wifi y no lo consigues, lo primero que debes hacer es asegurarte de que **estás introduciendo la clave wifi correctamente**.
2. Si la clave es correcta y continúas teniendo problemas para conectarte, **inténtalo con otro dispositivo** que tengas a mano (Tablet o celular).

Si aún no tiene conexión wifi, el problema sigue siendo el celular:

1. Comprueba que puedes conectarte a otra red wifi. En el caso de que falle, el problema está relacionado con tu celular. Para arreglarlo **puedes intentar actualizar el software o restaurar tu celular de fábrica**.
 2. Si puedes acceder al router, **apágalo y enciéndelo de nuevo**. A veces el problema viene de ahí.
 3. Si tu celular tiene la opción de "compartir internet", **comprueba que no esté activada** porque puede que eso impida al celular recibir señal.
 4. Para reiniciar la red wifi en tu celular, accede a los ajustes de wifi de tu celular donde se encuentran las redes disponibles, selecciona la red deseada y selecciona la opción "olvidar". Apaga el wifi del celular durante 10 segundos, reinicia la opción de wifi y **busca de nuevo la red deseada para reingresar la clave correcta**.
- Si nada de esto te funciona, deberías llamar a un técnico o a tu proveedor de servicios de internet para que te dé la solución necesaria.



Check the Wifi network, make sure you are connected to the Wi-Fi with your cell phone.

What to do if there is no signal?

1. If you try to connect to a new WiFi network and do not get it, the first thing you should do is **make sure that you are entering the WiFi password correctly**.
2. If the key is correct and you continue to have problems connecting, **try another device** that you have on hand (Tablet or cell).

If you still do not have WiFi connection, the problem remains the cell phone:

1. check that you can connect to another WiFi network. In case it fails, the problem is related to your cell phone. To fix it **you can try to update the software or restore your phone from the factory**.
2. If you can access the router, **turn and turn again**. Sometimes the problem comes from there.
3. If your phone has the option to "share the Internet", **check that it is not activated** because it may prevent the phone from receiving signal.
4. To restart the WiFi network on your mobile phone, access the WiFi settings on your mobile phone where the networks are available, select the desired network and select the "Forget" option. Turn off the WiFi on the phone for 10 seconds, restart the WiFi option and **search again for the desired network to re-enter the correct key**.

If none of this works for you, you should call a technician or your Internet service provider to give you the necessary solution.

3 Control IOT: es un control que permite accionar la bomba y las luces led, a través del panel y aplicación móvil, este **funciona con llenado automático y vaciado automático**. El panel de control se compone de tres botones, de izquierda a derecha: **Luces, Blower y Bomba**.

IOT control: It is a control that allows to operate the pump and the LED lights, through Panel and mobile application, this works with **automatic filling and automatic draining**. The control Panel consists of three buttons, from left to right: lights, Blower and pump.

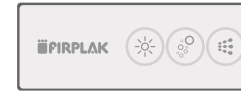

Aplicación EWeLink: Permite el control de todas las funciones a través del celular.

EWeLink application: Allows the control of all the functions through the cell phone.



4 Descarga la APP (EWelink) en las plataformas para descargar aplicaciones de tu smartphone ya sea App Store / Google Store.

Download the APP (EWelink) on the platforms to download applications from your smartphone, whether App Store / Google Store.



Configuración del sistema / System configuration

1 Registro y creación de usuario en la aplicación:
User registration and creation in the application:

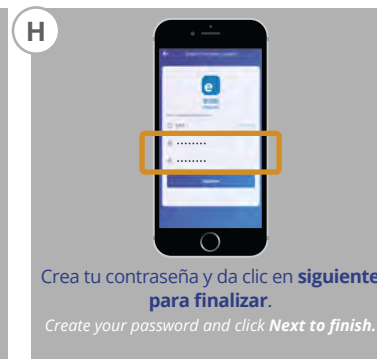
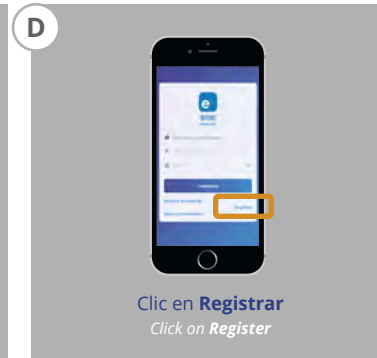
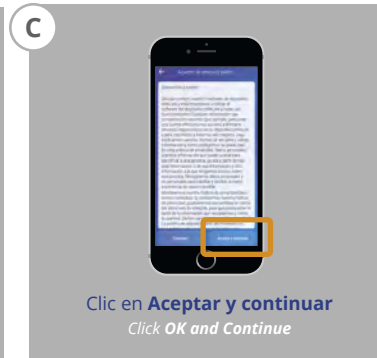
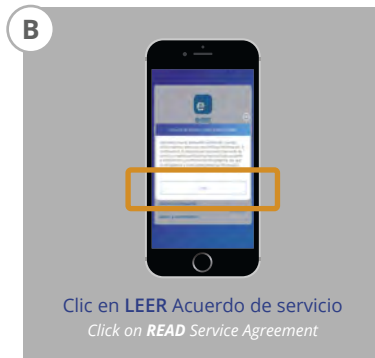

2 Enlaza la aplicación (APP EWelink) con el hidromasaje IOT: *Link the application (APP EWelink) with the Whirlpool bath IOT:*

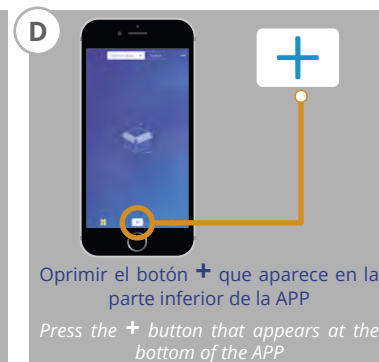
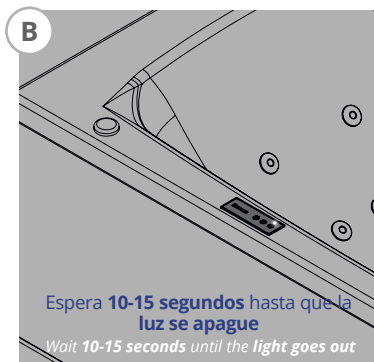
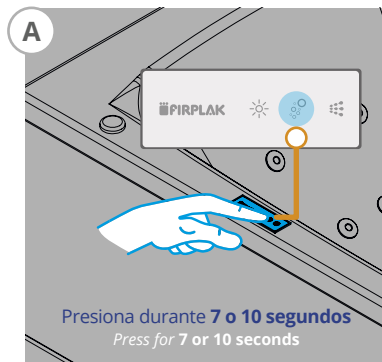



4 **Controles para tu hidromasaje:** Al tocar el recuadro blanco que contiene los botones (vistos en el paso anterior), aparecerá la pantalla que se muestra en la siguiente figura, este será tu control para manejar las terapias de tu hidromasaje.

Controls for your hydromassage: When touching the white box containing the buttons (seen in the previous step), the screen shown in the following figure will appear, this will be your control to manage the therapies of your whirlpool.

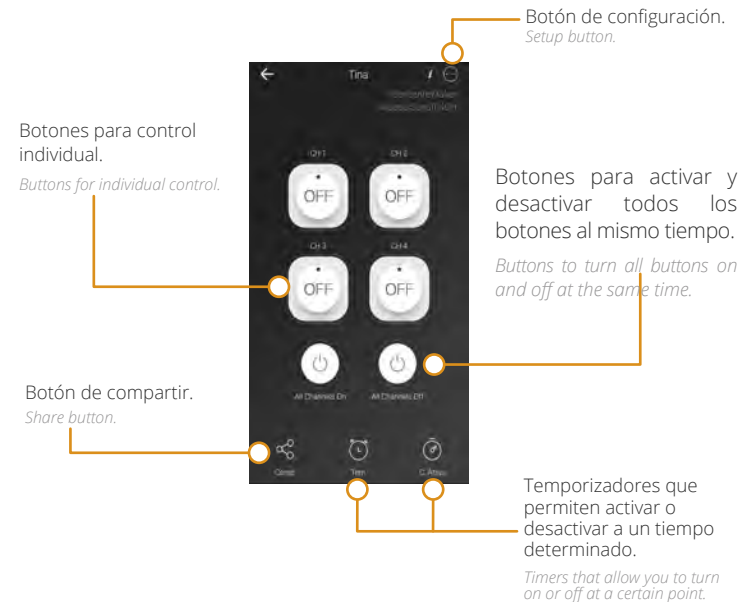

3 Configuración inicial luego de conectar el control IOT a la red WIFI.
Initial configuration after connecting the IOT control to the WIFI network.

La aplicación **EWelink** provee **4 canales de comunicación** los cuales se usan para el control IOT

The **EWelink** application provides **4 communication channels** which are used for the IOT control

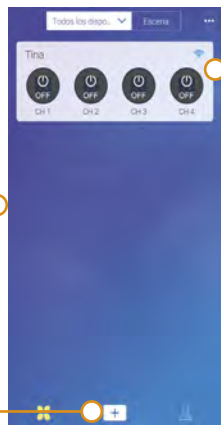

- Canal 1: ON.
 - Canal 2: Bomba.
 - Canal 3: Blower
 - Canal 4: Luces.
- Channel 1: ON.
 - Channel 2: Pump.
 - Channel 3: Blower
 - Channel 4: Lights.

Botón de configuración Wifi
WiFi Configuration button



- 5 Configuración del dispositivo:** Al tocar el botón de configuración en la parte superior derecha (vea el botón en el paso anterior) aparecerá un menú de ajustes y eliminar. Si selecciona la opción nombre, aparecerá la pantalla que se muestra en la siguiente **figura 1**, la cual permite cambiar el nombre del control (elijan un nombre fácil) de cada uno de los botones.

Device configuration: When you touch the configuration button at the top right (see the button in the previous step) a menu of settings will appear and delete.

If you select the name option, the display shown in the following **figure 1** will appear, which allows you to change the name of the control (Choose an easy name) and each of the buttons.

Figura 1
figure 1



Figura 2
figure 2



- 6** Una vez cambiado el nombre de los botones la aplicación luciría como se ve en la siguiente figura.

After changing the name of the buttons the application would look as seen in the following figure.

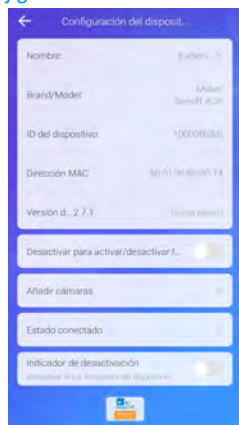
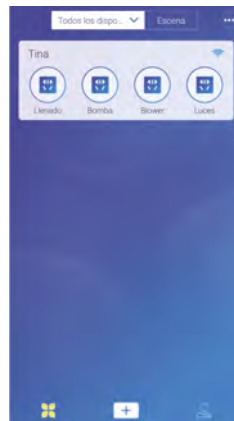

IMPORTANTE: Para que tenga efecto la funcionalidad de cualquier botón en la APP, **siempre debe estar encendido el canal 1** que generalmente será el de inicio.

Si alguno de los demás botones se oprime al estar el primero apagado entonces no se entenderá esta orden y el botón volverá a su estado de apagado.

El estado del teclado se notará en la APP y viceversa.

IMPORTANT: To have effect on the functionality of any button in the APP, **Channel 1 (bath fill) should always be on** that will usually be the startup. If any of the other buttons are pressed when the first one is turned off then this command will not be activated and the button will return to its off state.

The state of the keyboard will be present in the APP and vice versa.

Después de este último paso quedará todo listo para que disfrute de su sistema de hidromasaje, desde donde se encuentre.

Para dudas sobre el uso del producto que adquirió o piensa adquirir **contacte al asesor de su zona o comuníquese con el departamento de servicio técnico de Firplak S.A al TEL: 444 17 71 ext: 108.**

After this last step you will be ready to enjoy your Whirlpool system, from where you are. For questions about the use of the product you purchased or plan to purchase **contact your local advisor or contact the Firplak Technical Service department at TEL: 444 17 71 Ext: 108.**





www.firplak.com

Sede principal: Calle 29 N° 41-15 (Itagüí - Antioquia), Teléfono: (574) 444 17 71

Puede solicitar el mantenimiento con el **Servicio técnico de Firplak** Tel: +57 (4) **444 17 71 ext 108.**

Para mercado externo, por favor contacte su distribuidor local.

Contact your local dealer